

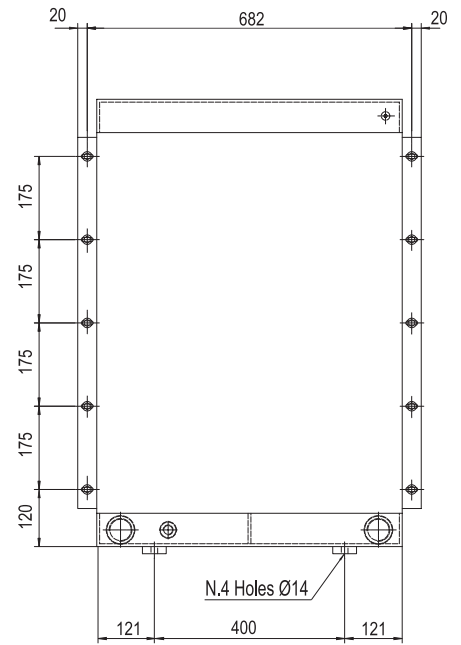

Serie HPA

HPA 52 2 PASS

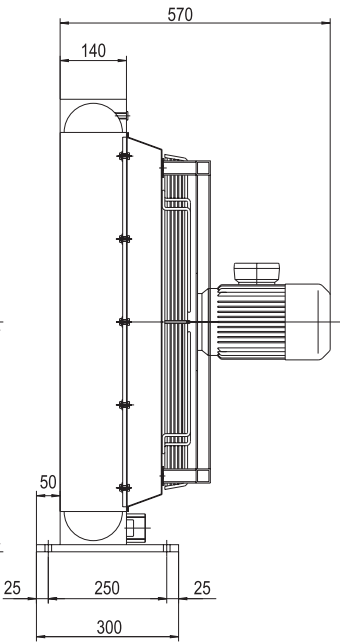
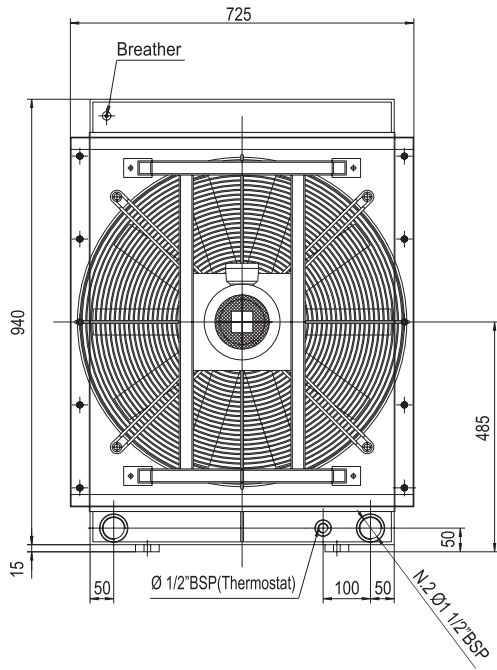

P/N 245403###

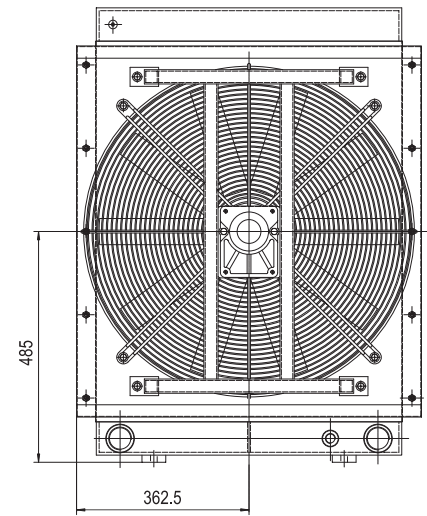
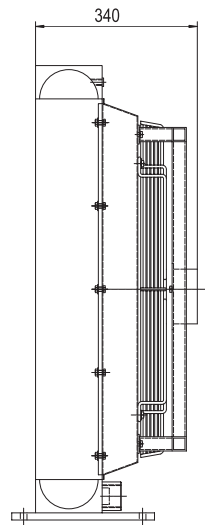
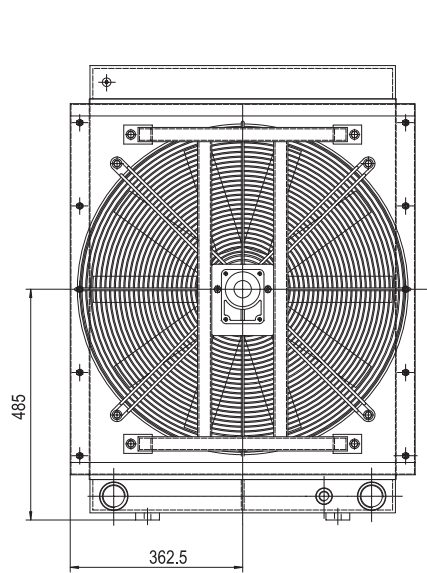

P/N 245456###

P/N 245458###

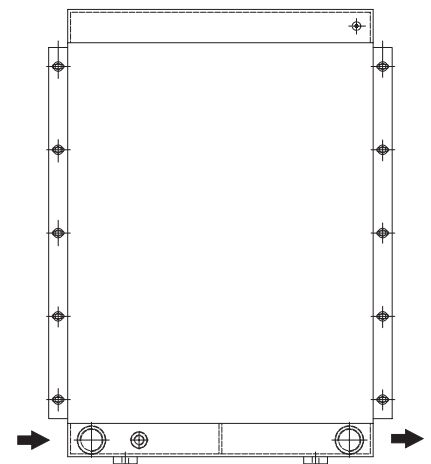
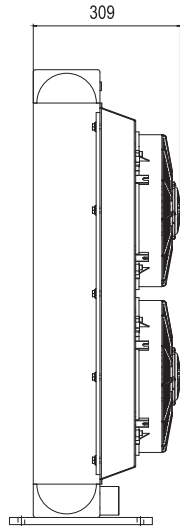
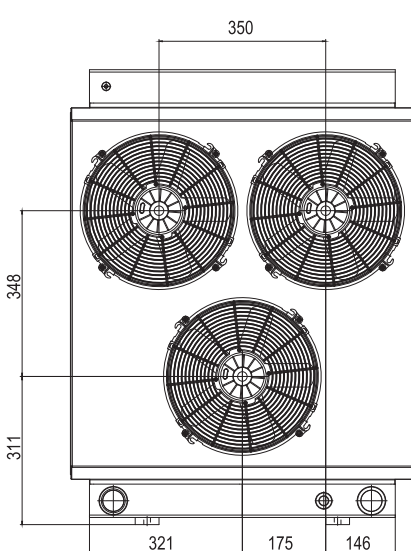

P/N 245412###
P/N 245424###

Le dimensioni di ingombro e le caratteristiche tecniche non sono impegnative
Overall dimensions and technical characteristic are not binding



Dati tecnici *Technical Data*

P/N	V	Hz	kW(±10%)	A(±10%)	rpm	Ø Fan	dB (A)	(m³/h)	IP	lt	kg
245403###	230-400 B14 AC	50	1,1	5-2,9	936	630	80	7050	55	17,7	95
	265-460 B14 AC	60	1,3	5-2,9	1123		☒	☒			
245456###	Prepared for Gr.2 hydraulic motor				☒	630	☒	☒	/	17,7	89
245458###	Prepared for Gr.3 hydraulic motor				☒	630	☒	☒	/	17,7	89
245412###	12	-	0,21	16,1	☒	305	☒	☒	68	17,7	89
245424###	24	-	0,21	8,5	☒	305	☒	☒	68	17,7	89

I dati si riferiscono al singolo ventilatore
Data refers to each fan

☒ Contattare EMMEGI Contact EMMEGI

Diagramma rendimento *Performance diagram*

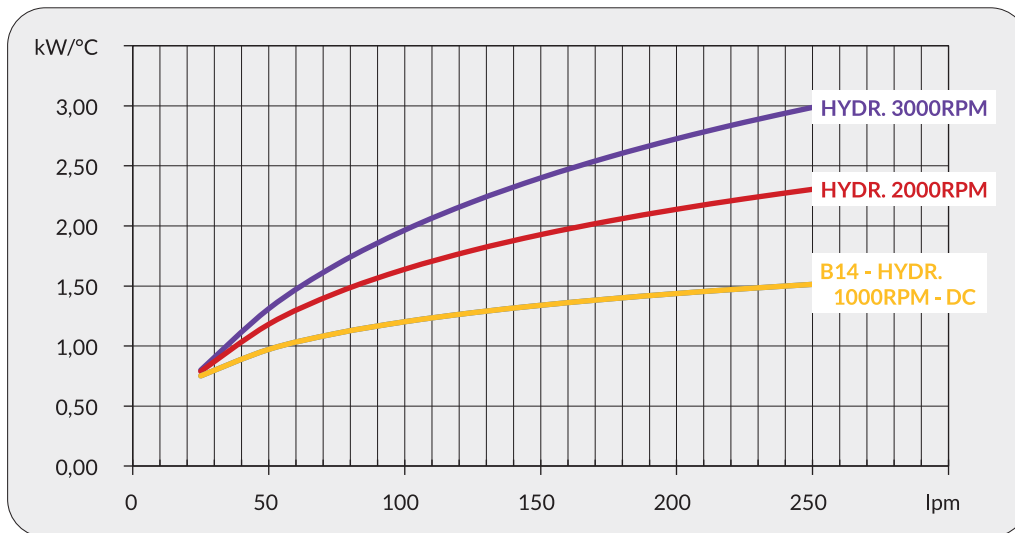

Perdite di carico *Pressure drop (@30cSt)*

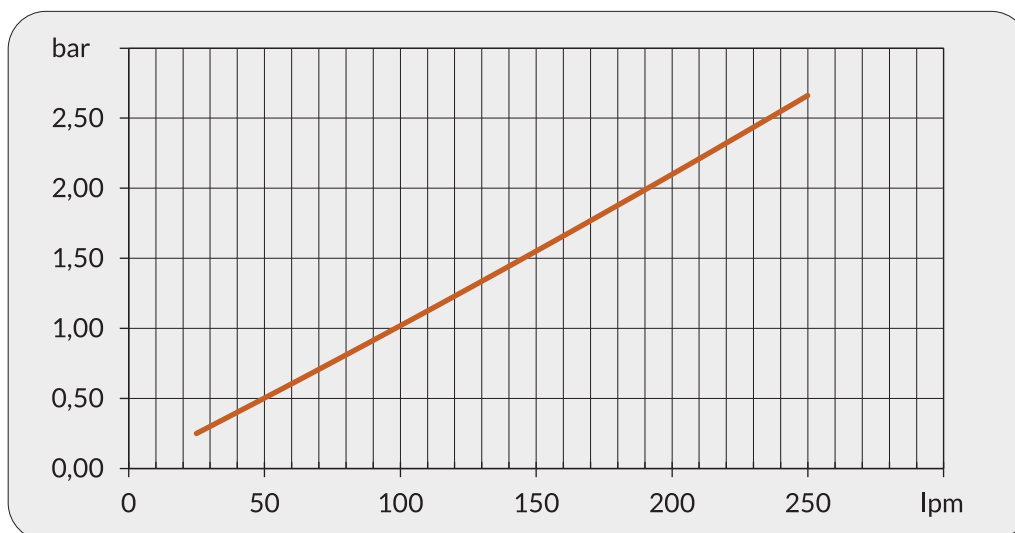

Fattore di correzione-F-(perdite di carico) *Correction factor-F-(pressure drop)*

cSt	10	15	20	30	40	50	60	80	100	200	300
F	0,5	0,65	0,77	1	1,2	1,4	1,6	1,9	2,1	3,3	4,3