

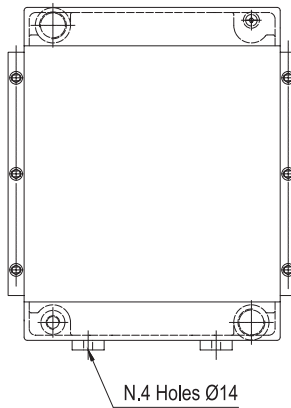

Serie HPA

HPA 24

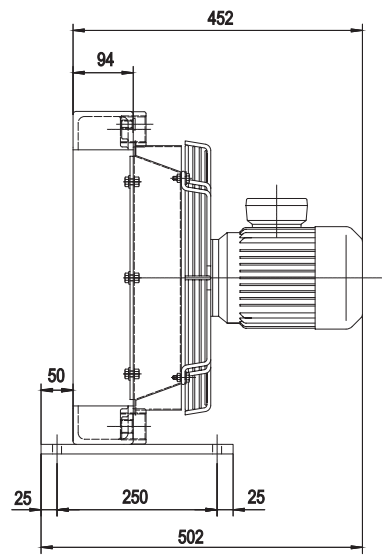
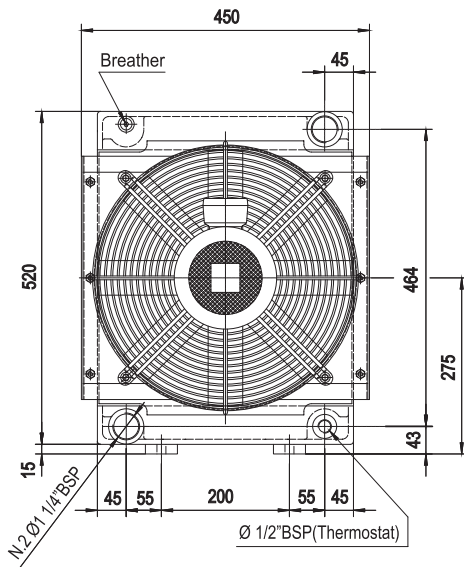

P/N 242403###

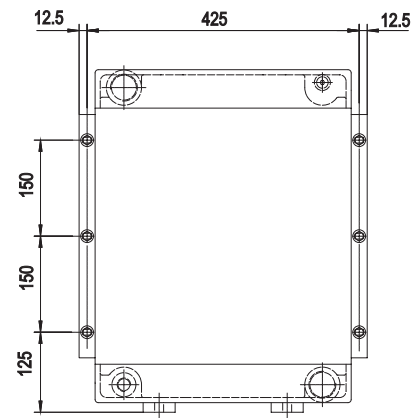
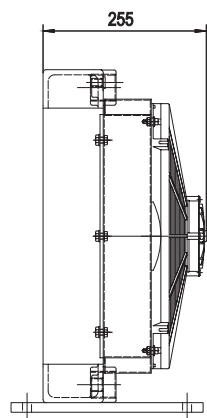
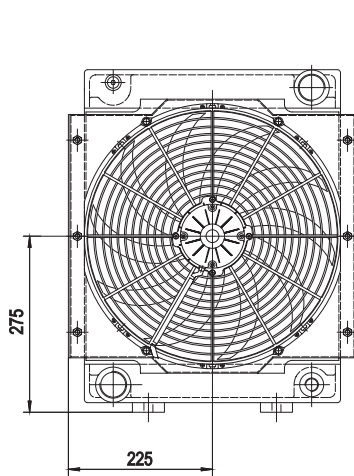

P/N 242412###
P/N 242424###

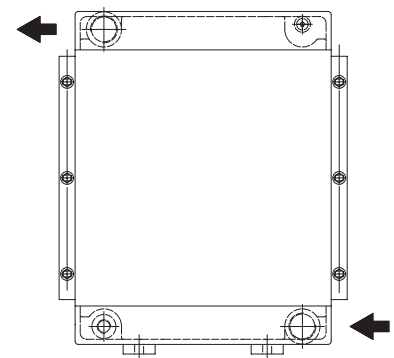
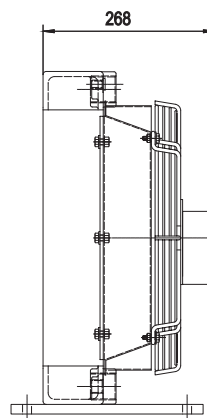
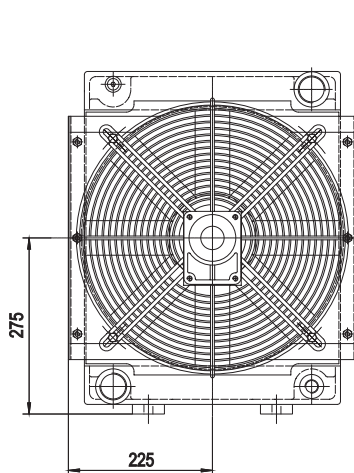

P/N 242456###

Le dimensioni di ingombro e le caratteristiche tecniche non sono impegnative
Overall dimensions and technical characteristic are not binding



Dati tecnici *Technical Data*

P/N	V	Hz	kW(±10%)	A(±10%)	rpm	Ø Fan	dB (A)	(m ³ /h)	IP	lt	kg
242403###	230-400 B14 AC	50	0,55	2,5 - 1,5	1220	400	79	1850	55	2,9	28
	265-460 B14 AC	60	0,63	2,5 - 1,5	1710		☎	☎			
242412###	12 DC	/	0,24	20,3	2580	385	77	2250	68	2,9	28
242424###	24 DC	/	0,23	9,7	2580	305	80	2250	68	2,9	22
242456###	Prepared for Gr.2 hydraulic motor				☎	400	☎	☎	/	2,9	23

☎ Contattare EMMEGI Contact EMMEGI

Diagramma rendimento *Performance diagram*

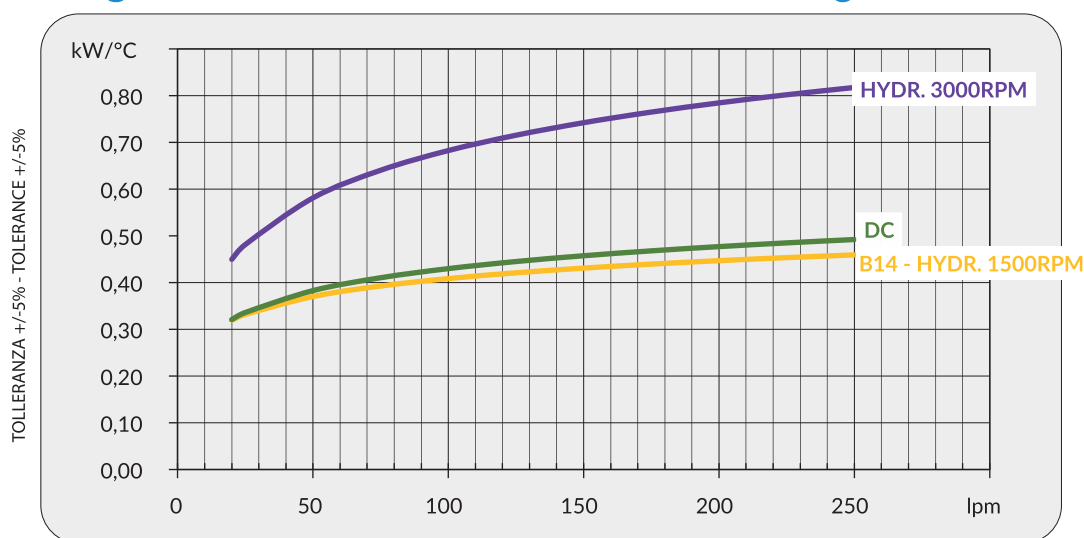

Perdite di carico *Pressure drop (@30cSt)*

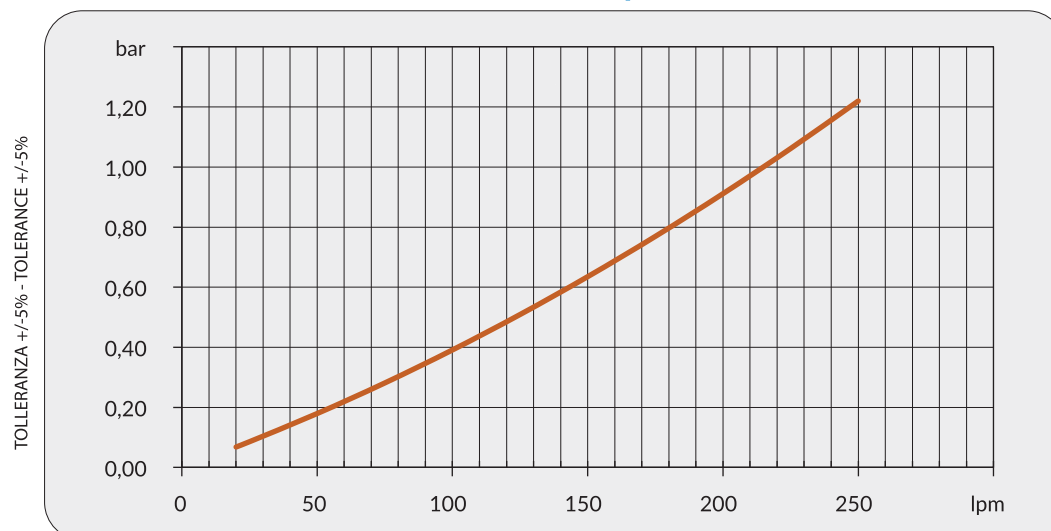

Fattore di correzione-F-(perdite di carico) *Correction factor-F-(pressure drop)*

cSt	10	15	20	30	40	50	60	80	100	200	300
F	0,5	0,65	0,77	1	1,2	1,4	1,6	1,9	2,1	3,3	4,3