

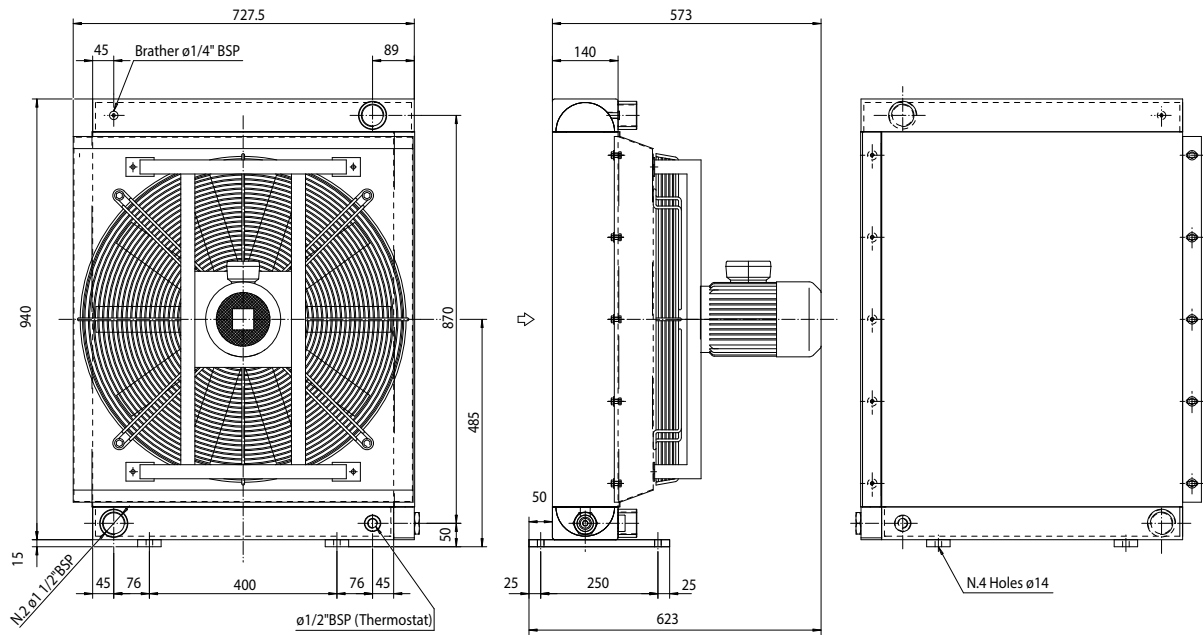

Serie HPV

HPV 52



P/N 2V5203###

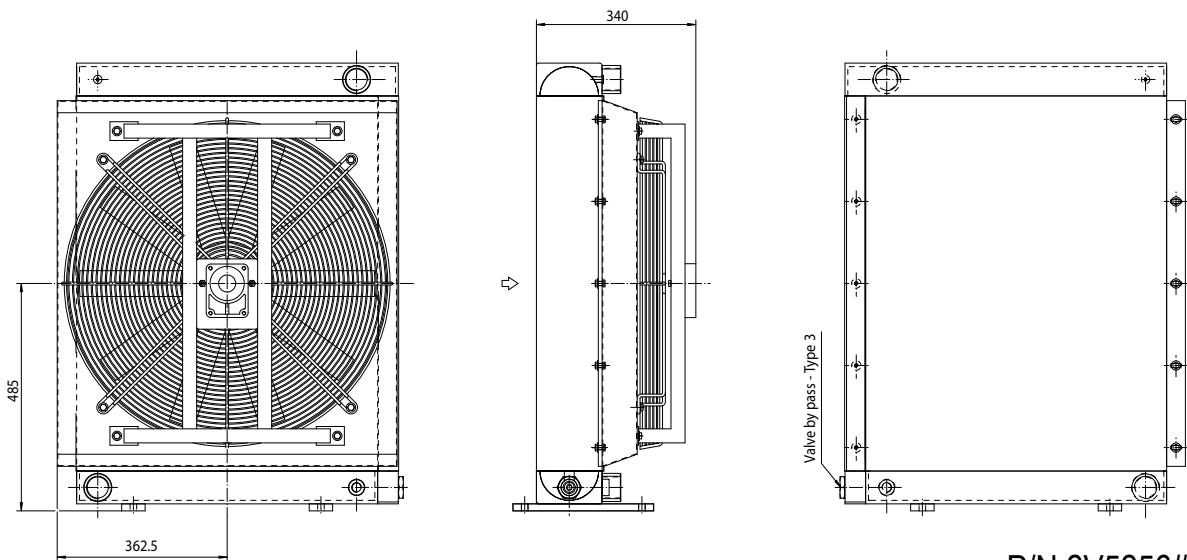

P/N 2V5256###

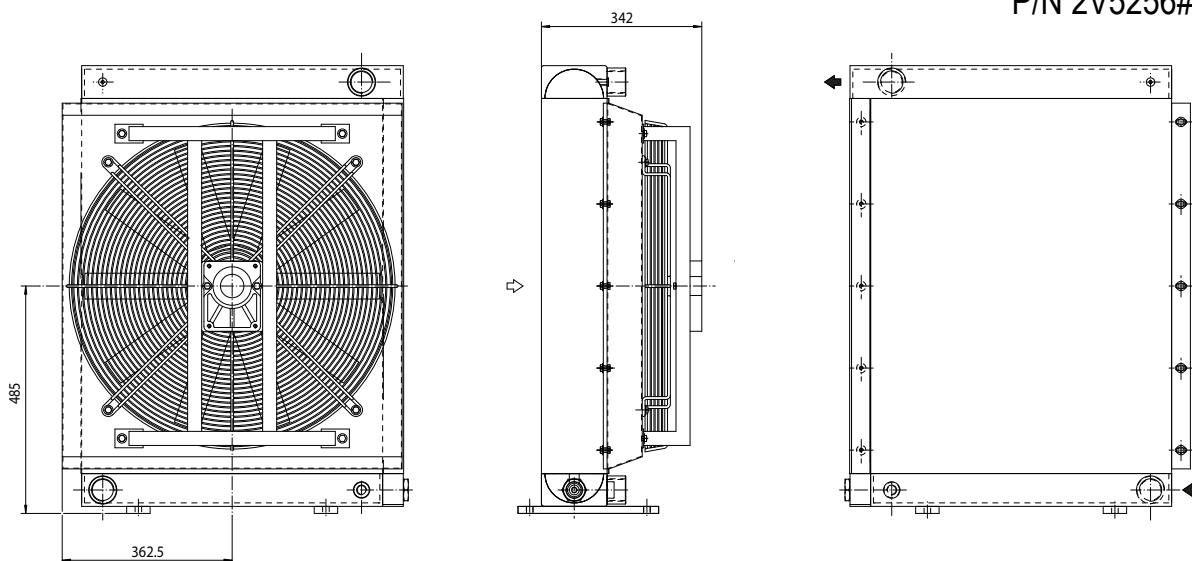

P/N 2V5258###

Le dimensioni di ingombro e le caratteristiche tecniche non sono impegnative
Over-all dimensions and technical characteristic are not binding



Dati tecnici Technical Data

P/N	V	Hz	kW(±10%)	A(±10%)	rpm	Ø Fan	dB (A)	(m³/ h)	IP	It	Kg
2V5203###	230-400 B14 AC 265-460 B14 AC	50 60	1,1 1,3	5 - 2,9 5 - 2,9	936 1123	630	80	7050	55	17,7	95
2V5256###	Prepared for Gr.2 hydraulic motor					630			/	17,7	89
2V5258###	Prepared for Gr.2 hydraulic motor					630			/	17,7	89

Contattare EMMEGI Contact EMMEGI

Diagramma rendimento Performance diagram

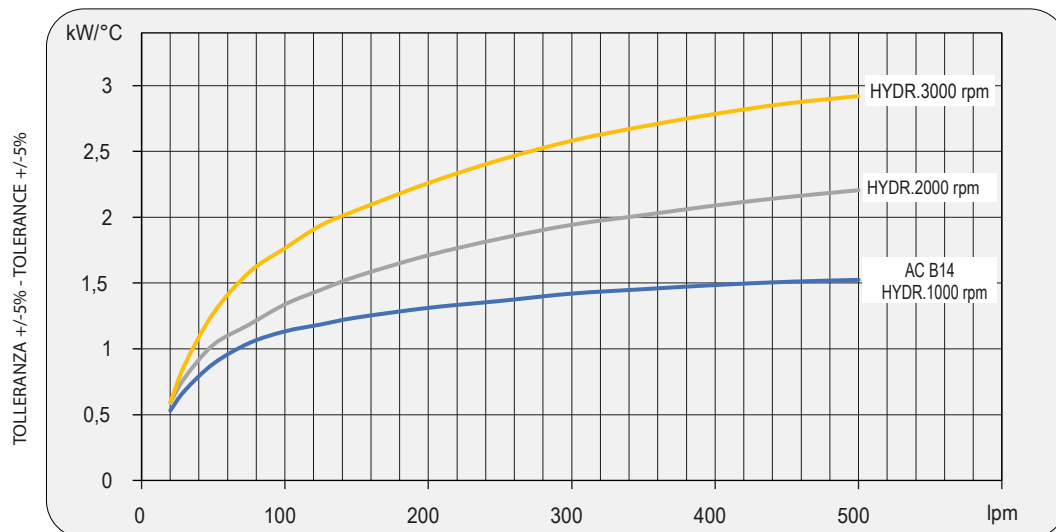

Perdite di carico Pressure drop (ISO VG 32)

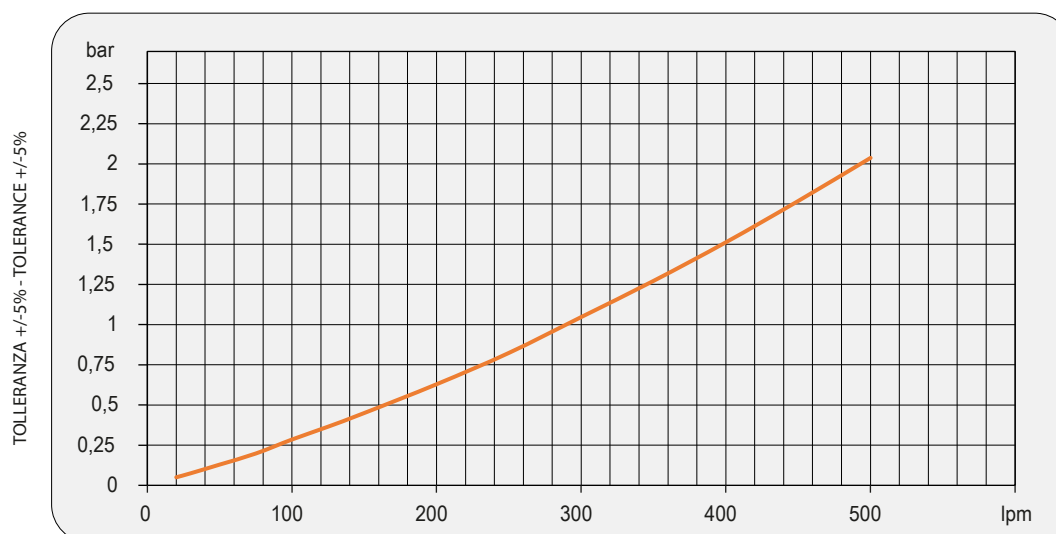

Fattore di correzione-F-(perdite di carico) Correction factor-F-(Pressure drop)

cst	10	15	20	30	40	50	60	80	100	200	300
F	0,5	0,65	0,77	1	1,2	1,4	1,6	1,9	2,1	3,3	4,3